

Description

The SMDJ series is designed specifically to protect sensitive electronic equipment from voltage transients induced by lightning and other transient voltage events.

Features

- I Low profile package
- I Matte tin lead-free Plated
- I Halogen free and RoHS compliant
- I Low incremental surge resistance
- I Typical IR less than 2μA above 10V
- I Compatible with industrial standard package DO-214AB
- I For surface mounted applications to optimize board space
- I 3000W peak pulse power capability with at 10/1000μs waveform, repetition rate (duty cycle): 0.01%
- I High temperature soldering:260°C/10 seconds at terminals

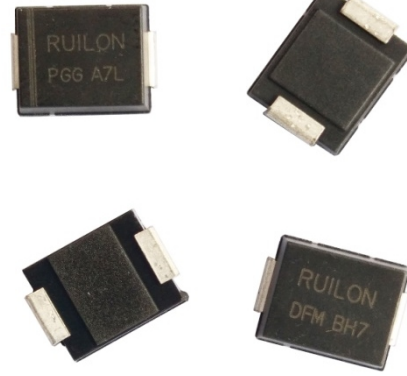

Electrical symbol

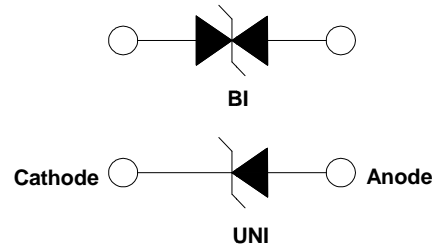

Part Number Code

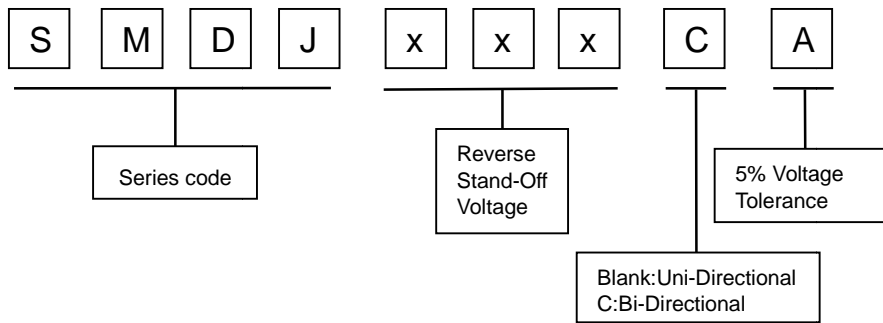

Mechanical Characteristics

Rating	Symbol	Value	Units
Peak Pulse Power Dissipation at $T_A=25^{\circ}\text{C}$ by 10/1000μs Waveform (Fig.2)(Note 1), (Note 2)	P_{PP}	3000	W
Power Dissipation on Infinite Heat Sink at $T_L=75^{\circ}\text{C}$ (Fig.6)	P_D	6.5	W
Peak Forward Surge Current, 8.3ms Single Half Sine Wave (Note 3)	I_{FSM}	300	A
Operating Temperature Range	T_J	-55 to 150	$^{\circ}\text{C}$
Storage Temperature Range	T_{STG}	-55 to 150	$^{\circ}\text{C}$

Notes:

1. Non-repetitive current pulse , per Fig. 4 and derated above $T_A = 25^{\circ}\text{C}$ per Fig. 3.
2. Mounted on 5.0x5.0mm copper pad to each terminal.
3. Measured on 8.3ms single half sine wave or equivalent square wave for unidirectional device only.



Electrical Characteristics

Type Number		Marking		Reverse Stand-Off Voltage	Breakdown Voltage		Test Current	Max. Clamping Voltage 10/1000µs	Max. Peak Pulse Current 10/1000µs	Reverse Leakage
					V _{BR} @I _T					
					V _R					
UNI	BI	UNI	BI	V	Min	Max	mA	V	A	µA
SMDJ5.0A	SMDJ5.0CA	RDE	DDE	5.0	6.4	7.0	10	9.2	326.09	800
SMDJ6.0A	SMDJ6.0CA	RDG	DDG	6.0	6.67	7.37	10	10.3	291.26	800
SMDJ6.5A	SMDJ6.5CA	RDK	DDK	6.5	7.22	7.98	10	11.2	267.86	500
SMDJ7.0A	SMDJ7.0CA	PDM	DDM	7.0	7.78	8.6	10	12.0	250.0	200
SMDJ7.5A	SMDJ7.5CA	PDP	DDP	7.5	8.33	9.21	1	12.9	232.56	100
SMDJ8.0A	SMDJ8.0CA	PDR	DDR	8.0	8.89	9.83	1	13.6	220.59	50
SMDJ8.5A	SMDJ8.5CA	PDT	DDT	8.5	9.44	10.4	1	14.4	208.33	20
SMDJ9.0A	SMDJ9.0CA	PDV	DDV	9.0	10.0	11.1	1	15.4	194.81	10
SMDJ10A	SMDJ10CA	PDX	DDX	10.0	11.1	12.3	1	17.0	176.47	5
SMDJ11A	SMDJ11CA	PDZ	DDZ	11.0	12.2	13.5	1	18.2	164.84	2
SMDJ12A	SMDJ12CA	PEE	DEE	12.0	13.3	14.7	1	19.9	150.75	2
SMDJ13A	SMDJ13CA	PEG	DEG	13.0	14.4	15.9	1	21.5	139.53	2
SMDJ14A	SMDJ14CA	PEK	DEK	14.0	15.6	17.2	1	23.2	129.31	2
SMDJ15A	SMDJ15CA	PEM	DEM	15.0	16.7	18.5	1	24.4	122.95	2
SMDJ16A	SMDJ16CA	PEP	DEP	16.0	17.8	19.7	1	26.0	115.38	2
SMDJ17A	SMDJ17CA	PER	DER	17.0	18.9	20.9	1	27.6	108.70	2
SMDJ18A	SMDJ18CA	PET	DET	18.0	20.0	22.1	1	29.2	102.74	2
SMDJ19A	SMDJ19CA	PEB	DEB	19.0	21.1	23.3	1	30.8	97.47	2
SMDJ20A	SMDJ20CA	PEV	DEV	20.0	22.2	24.5	1	32.4	92.59	2
SMDJ22A	SMDJ22CA	PEX	DEX	22.0	24.4	26.9	1	35.5	84.51	2
SMDJ24A	SMDJ24CA	PEZ	DEZ	24.0	26.7	29.5	1	38.9	77.12	2
SMDJ26A	SMDJ26CA	PFE	DFE	26.0	28.9	31.9	1	42.1	71.26	2
SMDJ28A	SMDJ28CA	PFG	DFG	28.0	31.1	34.4	1	45.4	66.08	2
SMDJ30A	SMDJ30CA	PFK	DFK	30.0	33.3	36.8	1	48.4	61.98	2
SMDJ33A	SMDJ33CA	PFM	DFM	33.0	36.7	40.6	1	53.3	56.29	2
SMDJ36A	SMDJ36CA	PFP	DFP	36.0	40.0	44.2	1	58.1	51.64	2
SMDJ40A	SMDJ40CA	PFR	DFR	40.0	44.4	49.1	1	64.5	46.51	2
SMDJ43A	SMDJ43CA	PFT	DFT	43.0	47.8	52.8	1	69.4	43.23	2
SMDJ45A	SMDJ45CA	PFV	DFV	45.0	50.0	55.3	1	72.7	41.27	2
SMDJ48A	SMDJ48CA	PFX	DFX	48.0	53.3	58.9	1	77.4	38.76	2



Electrical Characteristics

Type Number		Marking		Reverse Stand-Off Voltage	Breakdown Voltage		Test Current	Max. Clamping Voltage 10/1000µs	Max. Peak Pulse Current 10/1000µs	Reverse Leakage	
					V _{RWM}	V _{BR} @I _T					
						Min					Max
UNI	BI	UNI	BI	V	V	V	mA	V	A	µA	
SMDJ51A	SMDJ51CA	PFZ	DFZ	51.0	56.7	62.7	1	82.4	36.41	2	
SMDJ54A	SMDJ54CA	PGE	DGE	54.0	60.0	66.3	1	87.1	34.44	2	
SMDJ58A	SMDJ58CA	PGG	DGG	58.0	64.4	71.2	1	93.6	32.05	2	
SMDJ60A	SMDJ60CA	PGK	DGK	60.0	66.7	73.7	1	96.8	30.99	2	
SMDJ64A	SMDJ64CA	PGM	DGM	64.0	71.1	78.6	1	103.0	29.13	2	
SMDJ70A	SMDJ70CA	PGP	DGP	70.0	77.8	86.0	1	113.0	26.55	2	
SMDJ75A	SMDJ75CA	PGR	DGR	75.0	83.3	92.1	1	121.0	24.79	2	
SMDJ78A	SMDJ78CA	PGT	DGT	78.0	86.7	95.8	1	126.0	23.81	2	
SMDJ80A	SMDJ80CA	PGB	DGB	80.0	88.8	97.6	1	129.6	23.15	2	
SMDJ85A	SMDJ85CA	PGV	DGV	85.0	94.4	104.0	1	137.0	21.9	2	
SMDJ90A	SMDJ90CA	PGX	DGX	90.0	100.0	111.0	1	146.0	20.55	2	
SMDJ100A	SMDJ100CA	PGZ	DGZ	100.0	111.0	123.0	1	162.0	18.52	2	
SMDJ110A	SMDJ110CA	PHE	DHE	110.0	122.0	135.0	1	177.0	16.95	2	
SMDJ120A	SMDJ120CA	PHG	DHG	120.0	133.0	147.0	1	193.0	15.54	2	
SMDJ130A	SMDJ130CA	PHK	DHK	130.0	144.0	159.0	1	209.0	14.35	2	
SMDJ140A	SMDJ140CA	PHB	DHB	140.0	155.0	171.0	1	226.8	13.23	2	
SMDJ150A	SMDJ150CA	PHM	DHM	150.0	167.0	185.0	1	243.0	12.35	2	
SMDJ160A	SMDJ160CA	PHP	DHP	160.0	178.0	197.0	1	259.0	11.58	2	
SMDJ170A	SMDJ170CA	PHR	DHR	170.0	189.0	209.0	1	275.0	10.91	2	
SMDJ180A	SMDJ180CA	PHT	DHT	180.0	200.0	220.0	1	291.6	10.29	2	
SMDJ190A	SMDJ190CA	PHV	DHV	190.0	211.0	232.0	1	307.8	9.75	2	
SMDJ200A	SMDJ200CA	PHW	DHW	200.0	224.0	247.0	1	324.0	9.26	2	
SMDJ220A	SMDJ220CA	PHX	DHX	220.0	246.0	272.0	1	356.0	8.43	2	
SMDJ250A	SMDJ250CA	PHZ	DHZ	250.0	279.0	309.0	1	405.0	7.41	2	
SMDJ300A	SMDJ300CA	PJE	DJE	300.0	335.0	371.0	1	486.0	6.17	2	
SMDJ350A	SMDJ350CA	PJG	DJG	350.0	391.0	432.0	1	567.0	5.29	2	
SMDJ400A	SMDJ400CA	PJK	DJK	400.0	447.0	494.0	1	648.0	4.63	2	
SMDJ440A	SMDJ440CA	PJM	DJM	440.0	492.0	543.0	1	713.0	4.21	2	

Notes: For bidirectional type having V_R of 10V and less, the I_R limit is double.



I-V Curve Characteristics

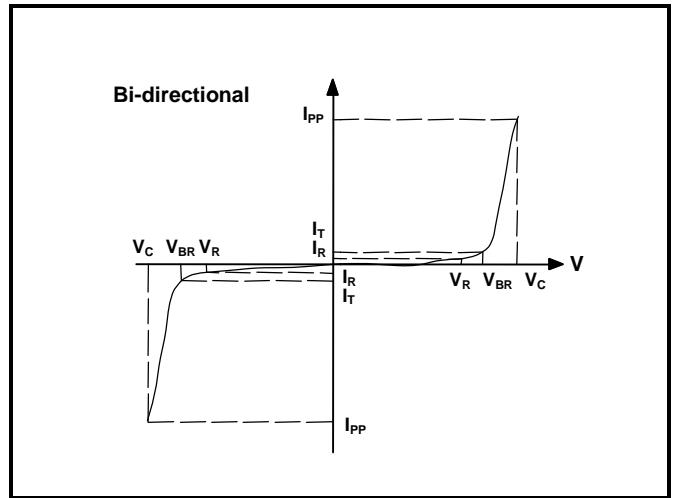
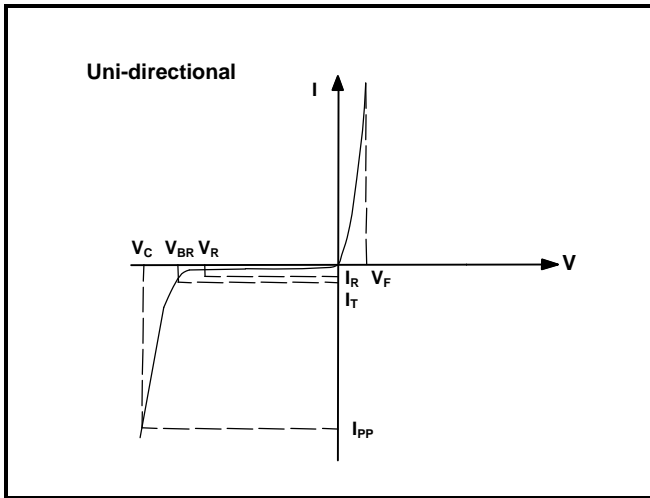

P_{PPM} Peak Pulse Power Dissipation -- Max power dissipation

V_R Stand-off Voltage -- Maximum voltage that can be applied to the TVS without operation

V_{BR} Breakdown Voltage -- Maximum voltage that flows through the TVS at a specified test current (I_T)

V_C Clamping Voltage -- Peak voltage measured across the TVS at a specified I_{ppm} (peak impulse current)

I_R Reverse Leakage Current -- Current measured at V_R

V_F Forward Voltage Drop for Uni-directional

Ratings and Characteristic Curves ($T_A=25^\circ\text{C}$ unless otherwise noted)

Figure 1 - TVS Transients Clamping Waveform

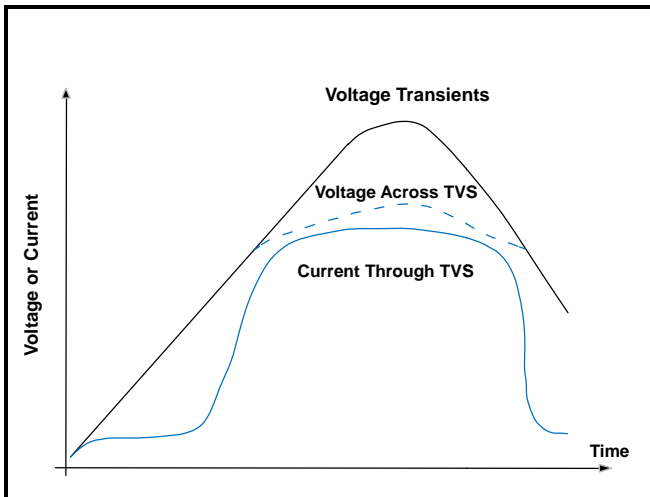
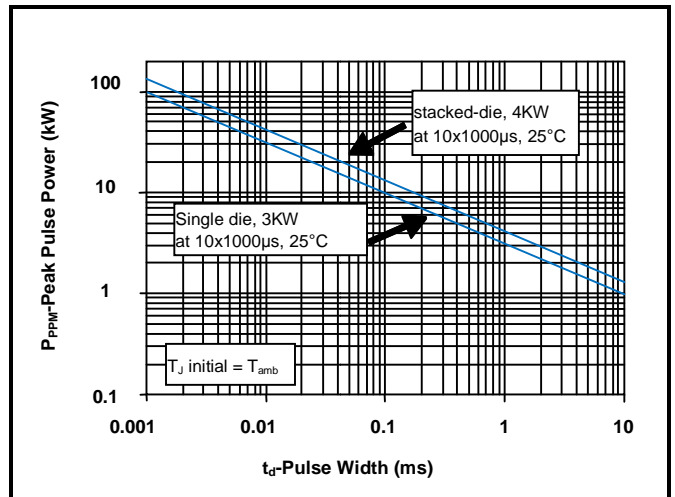

Figure 2 - Peak Pulse Power Rating Curve



Ratings and Characteristic Curves ($T_A=25^\circ\text{C}$ unless otherwise noted) (Continued)

Figure 3 - Pulse Derating Curve

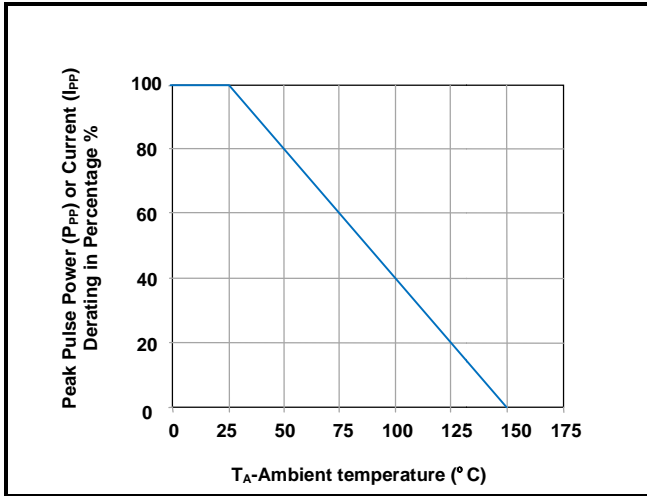

Figure 4 - Pulse Waveform

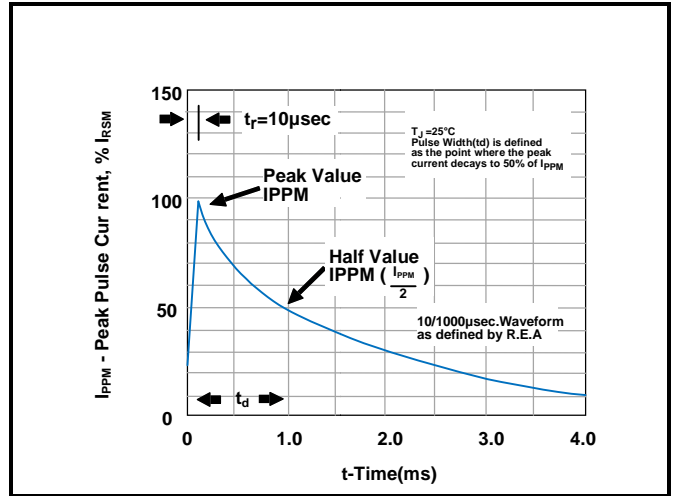

Figure 5 - Typical Junction Capacitance

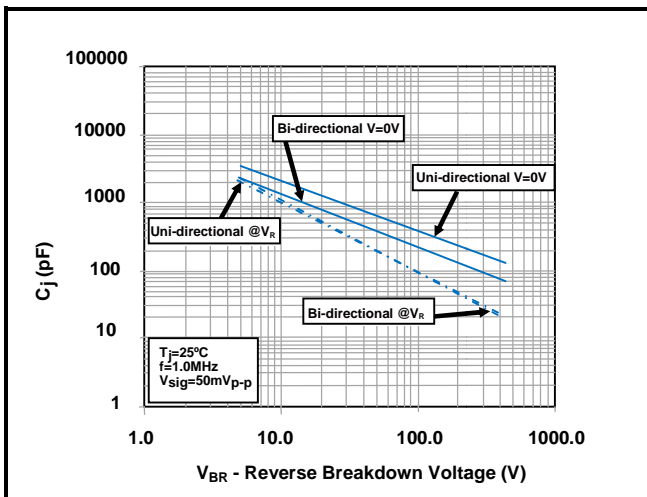

Figure 6 - Steady State Power Derating Curve

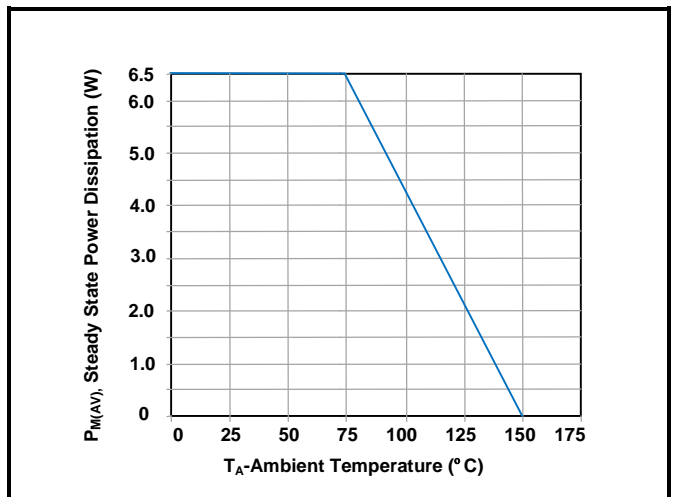
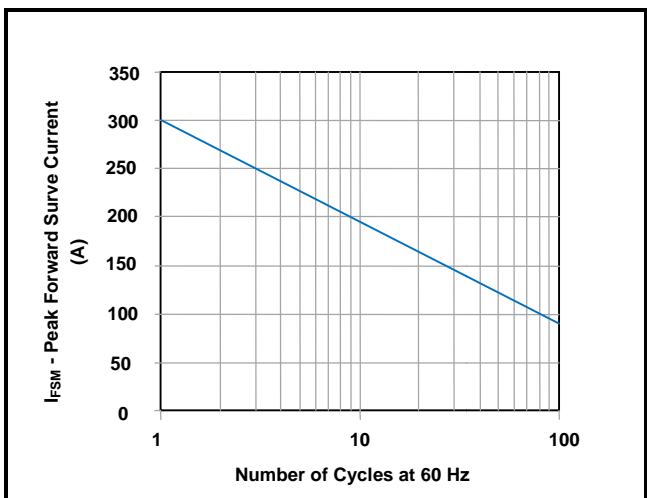
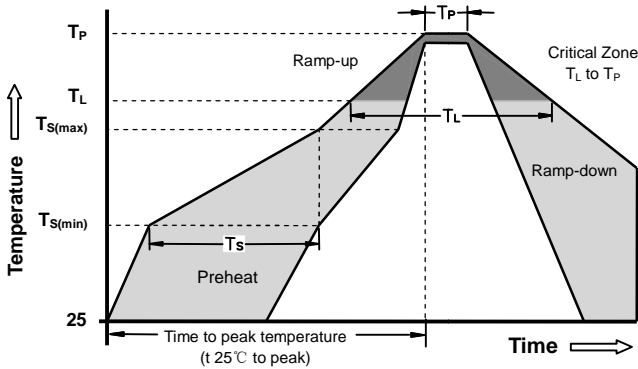

Figure 7 - Maximum Non-Repetitive Surge Current



Soldering Parameters - Reflow Soldering (Surface Mount Devices)



Reflow Condition		Pb - Free assembly
Pre Heat	-Temperature Min ($T_{s(min)}$)	150°C
	-Temperature Max ($T_{s(max)}$)	200°C
	- Time (min to max) (t_s)	60 - 180 Seconds
Average ramp up rate (Liquids Temp T_L to peak)		3°C/second max
$T_{s(max)}$ to T_L - Ramp-up Rate		3°C/second max
Reflow	- Temperature (T_L) (Liquids)	217°C
	- Time (min to max) (t_s)	60 - 150 Seconds
Peak Temperature (T_P)		260 +0/-5°C
Time within 5°C of actual peak Temperature (t_p)		20 - 40 Seconds
Ramp-down Rate		6°C/second max
Time 25°C to peak Temperature (T_P)		8 minutes Max
Do not exceed		260°C

Part Marking System

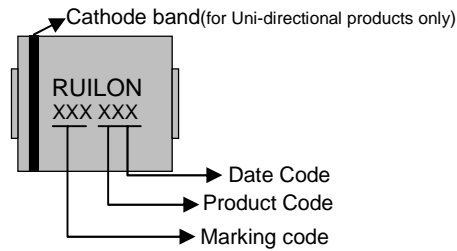

Dimensions

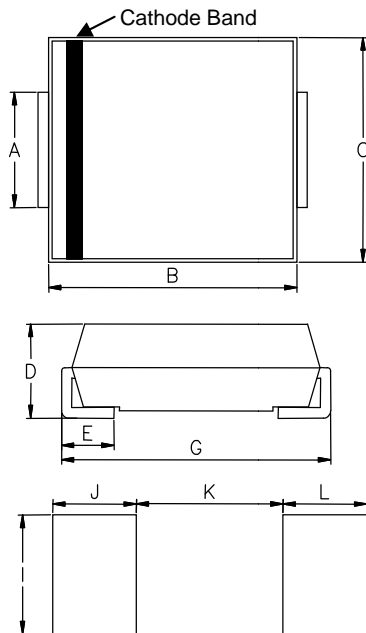

DIM	Millimeters		Inches	
	Min	Max	Min	Max
A	2.75	3.25	0.108	0.128
B	6.50	7.15	0.256	0.281
C	5.50	6.22	0.217	0.245
D	1.98	2.70	0.078	0.106
E	0.75	1.52	0.030	0.060
G	7.40	8.40	0.291	0.331
I	3.300	-	0.129	-
J	2.400	-	0.094	-
K	-	4.200	-	0.165
L	2.400	-	0.094	-



Taping and Reel Specifications

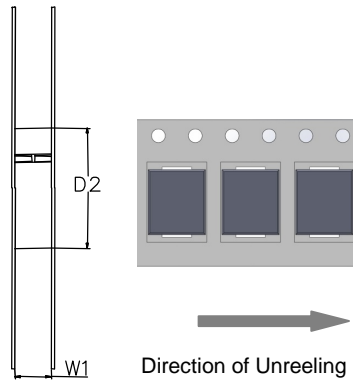
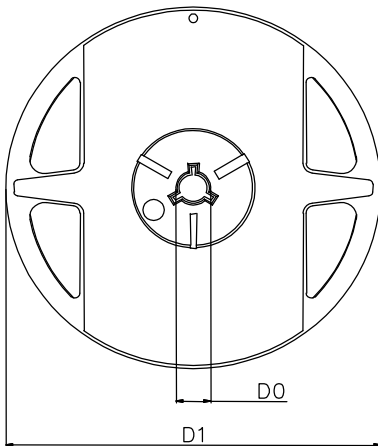
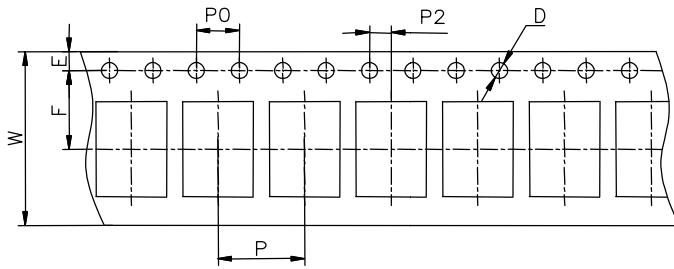

Symbol	Millimeters	Inches
W	16±0.3	0.630±0.012
P	8±0.1	0.315±0.004
F	7.25±0.1	0.285±0.004
E	1.75±0.1	0.069±0.004
D	1.5+0.1/-0.0	0.059+0.004/-0.0
P0	4±0.1	0.157±0.004
P2	2±0.1	0.079±0.004
D0	16.7±0.15	0.657±0.006
D1	178±2	7.007±0.079
D2	59.6+1/-2	2.346+0.039/-0.079
W1	17.2±0.4	0.677±0.016

Part Number	Component package	Quantity	Packaging option	Packaging specification
SMDJXXXA/CA	DO-214AB(SMC)	500	Tape&Reel-16mm/7"tape	EIA STD RS-481

